



## SALAMANDER BROILERS RADIANT AND INFRARED

VULCAN      36RB  
                  36IRB

WOLF         C36RB  
                  C36IRB



**This Manual is prepared for the use of trained Vulcan Service Technicians and should not be used by those not properly qualified.**

**This manual is not intended to be all encompassing. If you have not attended a Vulcan Service School for this product, you should read, in its entirety, the repair procedure you wish to perform to determine if you have the necessary tools, instruments and skills required to perform the procedure. Procedures for which you do not have the necessary tools, instruments and skills should be performed by a trained Vulcan Service Technician.**

**The reproduction, transfer, sale or other use of this Manual, without the express written consent of Vulcan, is prohibited.**

**This manual has been provided to you by ITW Food Equipment Group LLC ("ITW FEG") without charge and remains the property of ITW FEG, and by accepting this manual you agree that you will return it to ITW FEG promptly upon its request for such return at any time in the future.**

**For additional information on Vulcan-Hart Company or to locate an authorized parts and service provider in your area, visit our website at [www.vulcanequipment.com](http://www.vulcanequipment.com)**

# TABLE OF CONTENTS

|  |    |
|--|----|
| GENERAL .....  | 3  |
| INTRODUCTION .....                                       | 3  |
| INSTALLATION, OPERATION AND CLEANING .....               | 3  |
| RACK POSITION AND GAS SETTING .....                      | 3  |
| MODELS .....   | 3  |
| SPECIFICATIONS .....                                     | 3  |
| LUBRICATION .....  | 3  |
| TOOLS .....  | 3  |
| REMOVAL AND REPLACEMENT OF PARTS .....                   | 4  |
| MANIFOLD COVER .....                                     | 4  |
| TOP PANEL ASSEMBLY .....                                 | 4  |
| LEFT SIDE PANEL .....                                    | 4  |
| RIGHT SIDE PANEL .....                                   | 5  |
| CONTROL VALVES (36RB/C36RB) .....                        | 6  |
| PILOT (36RB/C36RB) .....                                 | 6  |
| RADIANT BURNER (36RB/C36RB) .....                        | 7  |
| CONTROL VALVES (36IRB/C36IRB) .....                      | 8  |
| PILOT (36IRB/C36IRB) .....                               | 9  |
| INFRARED BURNER (36IRB/C36IRB) .....                     | 10 |
| GAS PRESSURE REGULATOR .....                             | 12 |
| RACK SPRINGS .....                                       | 12 |
| SERVICE PROCEDURES AND ADJUSTMENTS .....                 | 13 |
| PILOT FLAME HEIGHT .....                                 | 13 |
| RADIANT BURNER AIR SHUTTER ADJUSTMENT (36RB/C36RB) ..... | 13 |
| INFRARED BURNER (36IRB/C36IRB) .....                     | 13 |
| ADJUSTMENT .....   | 13 |
| FLAME APPEARANCE .....                                   | 13 |
| REGULATOR ADJUSTMENT .....                               | 13 |
| GAS ORIFICE CHECK .....                                  | 14 |
| CONTROL VALVES .....                                     | 15 |
| RACK SPRING TENSION ADJUSTMENT .....                     | 15 |
| TROUBLESHOOTING .....                                    | 16 |
| GENERAL (ALL MODELS) .....                               | 16 |
| RADIANT BURNER (36RB/C36RB) .....                        | 16 |
| INFRARED BURNER (36IRB/C36IRB) .....                     | 16 |

# GENERAL

## INTRODUCTION

This manual is for the Vulcan and Wolf Gas Salamander Broilers. Procedures in this manual will apply to all models unless specified. Pictures and illustrations will be of model 36IRB unless otherwise noted.

All of the information, illustrations and specifications contained in this manual are based on the latest product information available at the time of printing.

## INSTALLATION, OPERATION AND CLEANING

For detailed installation, operation and cleaning instructions, refer to [Installation & Operation Manual](#) sent with each unit. The manual is also available online at [www.vulcanequipment.com](http://www.vulcanequipment.com).

**NOTE:** Using accessory options, Salamander broilers can be mounted to the wall, over a range or placed onto an appropriate table top by using 4" legs.

## RACK POSITION AND GAS SETTING

**NOTE:** Infrared burner models must use the full gas setting (knob fully counterclockwise) to achieve the best burner performance and highest broiler temperatures. Lower broiler temperatures can be achieved by using a lower gas setting (knob in the range just past off but less than fully counterclockwise). When using a lower gas setting, the flame should remain lit and be steady across the entire burner surface.

For detailed information refer to RACK POSITION AND GAS SETTING in the [Installation & Operation Manual](#).

## MODELS

### Vulcan

- 36RB - N (natural)
- 36RB - P (propane)

### Wolf

- C36RB - N (natural)
- C36RB - P (propane)

## SPECIFICATIONS

### Gas Pressures

- Manifold/Operating Pressure
    - Natural** - 5" W.C.
    - Propane** - 10" W.C.
  - Inlet Supply Pressure
    - Natural** - Recommended 7" - 9" W.C. ; Minimum 7" W.C.
    - Propane** - Recommended 11" - 12" W.C. ; Minimum 11" W.C.
- Maximum 14" W.C. (0.5 PSI) (Natural or Propane).

## LUBRICATION

Anderson and Forrester (or comparable) valve grease for burner valve stems. Apply light coat to valve stems. Valve grease must be insoluble in propane and natural gas.

## TOOLS

### Standard

- Standard set of hand tools.
- Manometer.

### Special

- 3/4" pipe tee, two short pipe nipples and a reducer (as required) to install hose barb to the tee. Assemble the parts and retain for future gas equipment use. The tool is used for measuring gas manifold pressure after the regulator when a pressure tap is not available in the gas manifold.

# REMOVAL AND REPLACEMENT OF PARTS

## MANIFOLD COVER

**⚠ WARNING** Shut off the gas before servicing the unit.

1. Loosen set screw and remove knobs from control valves.
2. Remove screws that secure manifold cover and remove the cover.
3. Reverse procedure to install.



Fig. 1

## TOP PANEL ASSEMBLY

**⚠ WARNING** Shut off the gas before servicing the unit.

**NOTE:** When viewed from the top, there are (5) flue bracket mounting screws that secure the bracket and the insulation pan (underneath) to the top panel only. When removing the top panel assembly, these screws can remain installed.

1. Remove LEFT SIDE PANEL and RIGHT SIDE PANEL.
2. Remove the remaining screws securing Top Panel Assembly to each side of the flue and back panel.
3. Lift the Top Panel Assembly off broiler.
4. Reverse procedure to install.

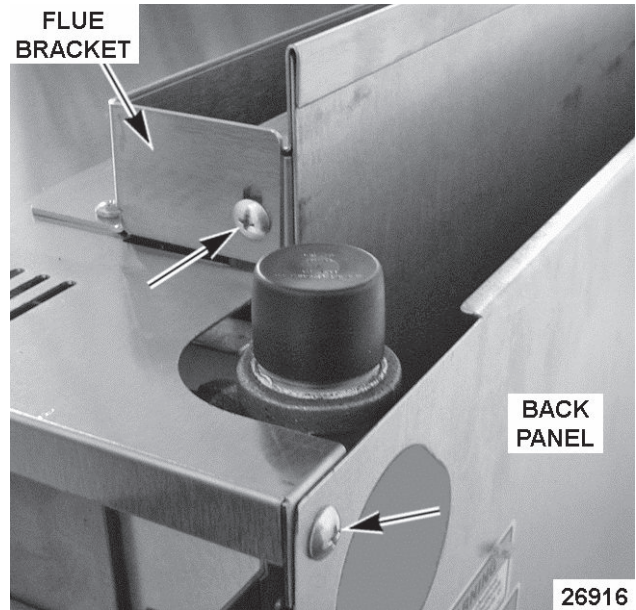

Fig. 2

## LEFT SIDE PANEL

**⚠ WARNING** Shut off the gas before servicing the unit.

1. Remove crumb tray.
2. Remove MANIFOLD COVER.
3. Position the rack assembly to access panel screws in the broiler opening area.

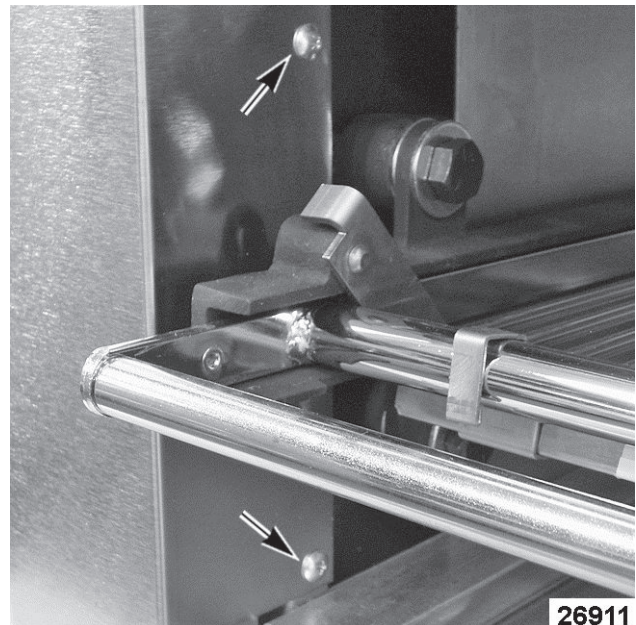

Fig. 3

- Remove screws securing left side panel. Slide panel toward the front of broiler until panel clears front mounting area then remove the panel.

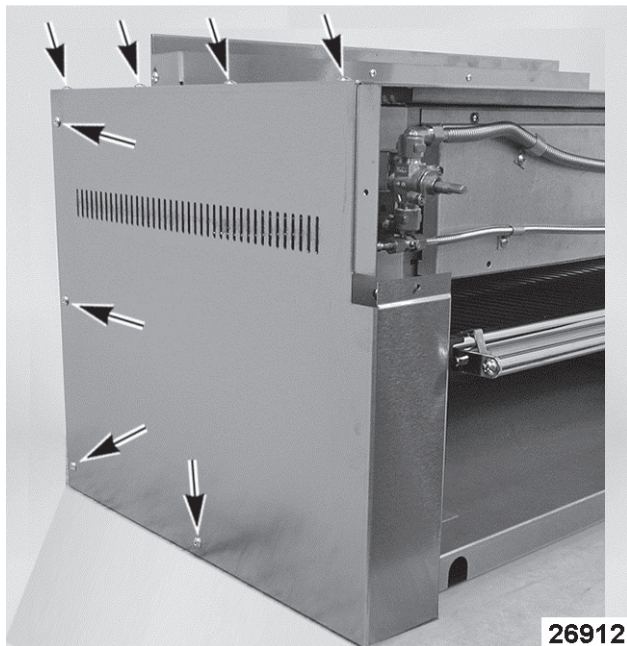

Fig. 4

- Pull knob off the handle on rack positioning bracket then remove plate stop.
- Position the rack assembly to access panel screws in the broiler opening area. Remove screws from this area and the front of panel.

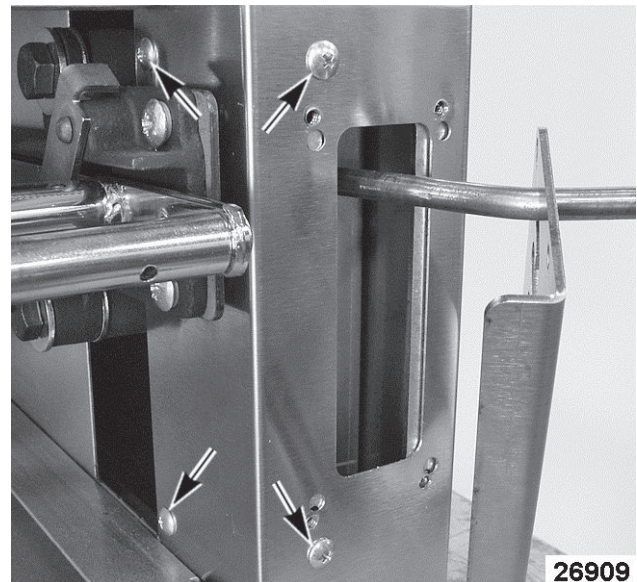

Fig. 6

- Reverse procedure to install.

## RIGHT SIDE PANEL

**⚠ WARNING** Shut off the gas before servicing the unit.

- Remove crumb tray.
- Remove MANIFOLD COVER.
- Remove screws securing plate stop to broiler.

### PLATE STOP

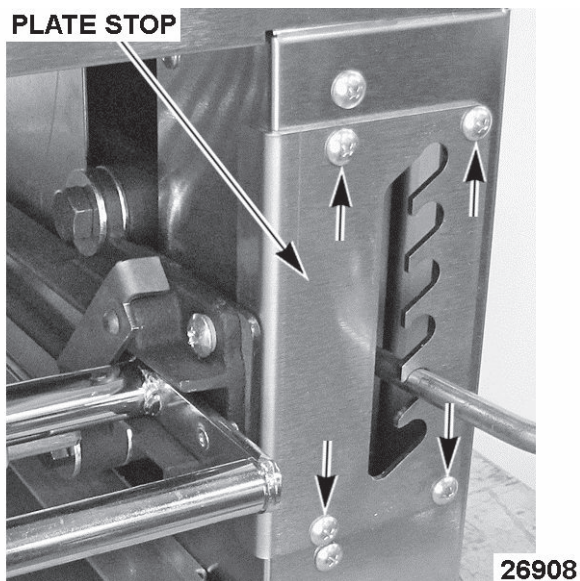

Fig. 5

- Remove screws securing right side panel to broiler. Slide panel toward the front of broiler until panel clears front mounting area then remove the panel.

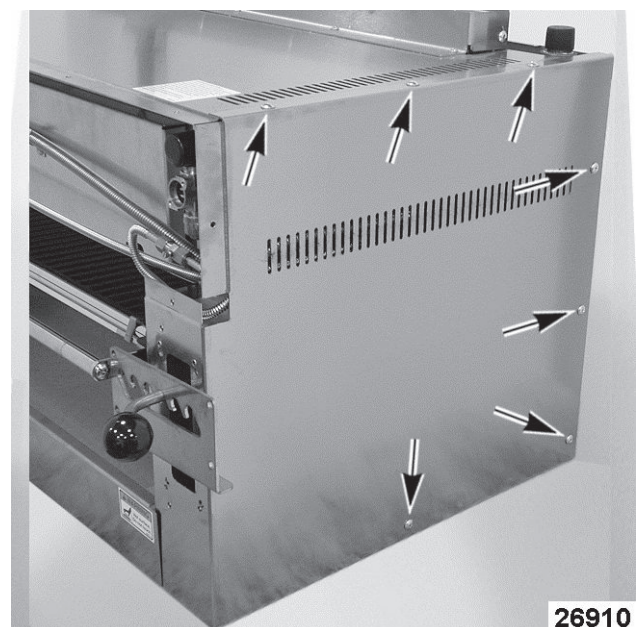

Fig. 7

- Reverse procedure to install.

## CONTROL VALVES (36RB/C36RB)

**⚠ WARNING** Shut off the gas before servicing the unit.

**⚠ WARNING** All gas joints disturbed during servicing must be checked for leaks. Check with a soap and water solution (bubbles). Do not use an open flame.

1. Remove MANIFOLD COVER.
2. Left Valve:
  - A. Disconnect compression fitting from top of valve.
  - B. Remove screws securing manifold to broiler.
  - C. Note orientation of elbow on valve then remove the elbow. Retain for use on replacement valve.
  - D. Remove valve from manifold.

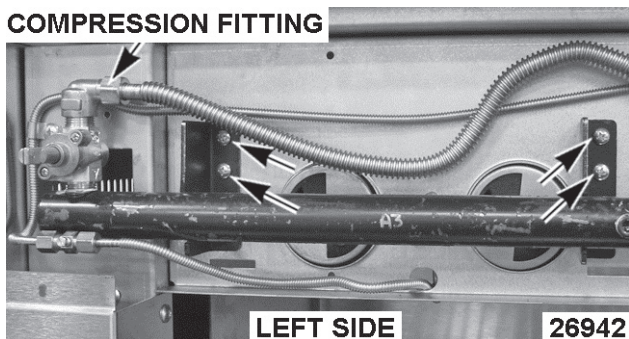

Fig. 8

3. Right Valve:
  - A. Remove RIGHT SIDE PANEL.
  - B. Disconnect compression fittings from right side manifold.
  - C. Remove screws securing right front manifold and right side manifold to broiler.
  - D. Note orientation of control valve then remove it from the each of the manifolds.

**NOTE:** When installing, ensure control valve is perpendicular to the right front manifold.

**⚠ WARNING** Clean pipe threads and apply thread sealant that is suitable for use with propane gases.

4. Reverse procedure to install.
5. Check for proper operation.

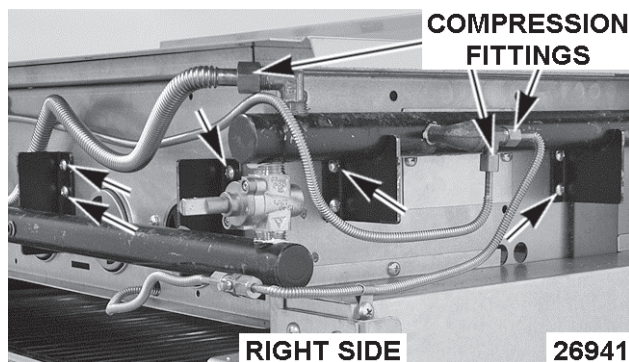

Fig. 9

## PILOT (36RB/C36RB)

**⚠ WARNING** Shut off the gas before servicing the unit.

**⚠ WARNING** All gas joints disturbed during servicing must be checked for leaks. Check with a soap and water solution (bubbles). Do not use an open flame.

1. Remove MANIFOLD COVER.
2. Disconnect compression nut from straight pilot valve fitting.

**NOTICE** When disconnecting compression nut from the straight pilot valve fitting, support the fitting to prevent damage to pilot flexible tubing.

3. Remove screws securing pilot and bracket to the broiler.

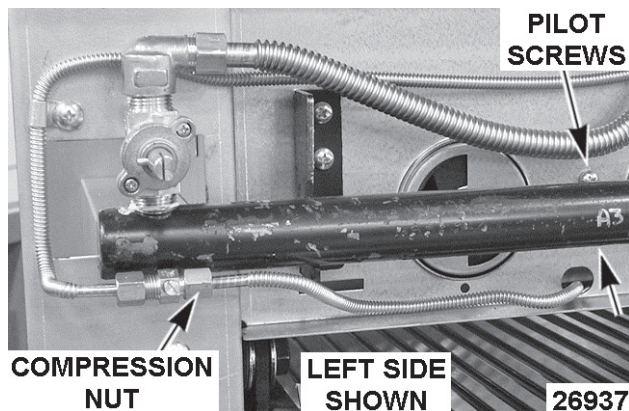

Fig. 10

4. Remove pilot through broiler cooking area.

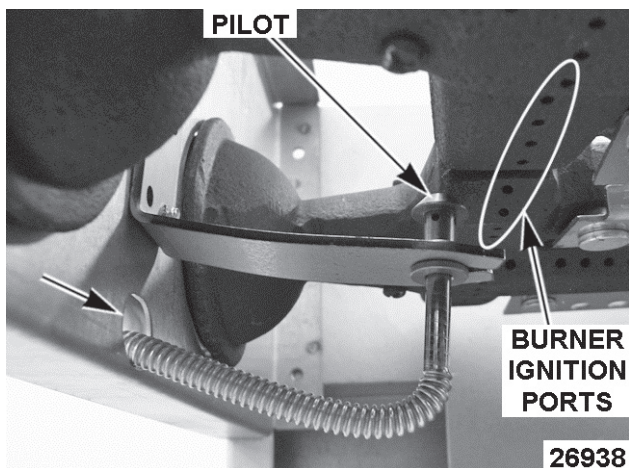

Fig. 11

5. Remove pilot from bracket.
6. To install replacement pilot:
  - A. Insert mounting groove on the pilot into the mounting slot on the pilot bracket.
  - B. Re-crimp the pilot bracket to secure the pilot.
  - C. Slide compression nut and sleeve (ferrule) over one end of the replacement flexible tubing for the pilot. Insert flexible tubing into the pilot and tighten compression nut to secure.
  - D. Bend flexible tubing to match original pilot configuration. Route flexible tubing through opening in broiler frame and install pilot bracket to broiler.

**NOTE:** When installing, ensure the pilot is close to the ignition ports on the bottom of burner for proper burner lighting. If necessary, bend the bracket so that the pilot remains in contact with the burner casting.

- E. Slide compression nut and sleeve over the opposite end of flexible tubing. Insert flexible tubing into the straight pilot valve on broiler and tighten compression nut to secure.

7. Check for proper operation.

## RADIANT BURNER (36RB/C36RB)

**⚠ WARNING** Shut off the gas before servicing the unit.

1. Adjust rack assembly to the center position.

2. Pull rack assembly out and access the rack stops on the left and right sides of the rack assembly. Allow enough clearance at the rear of rack assembly to rotate the rack stops to a horizontal position. If the rack assembly is pulled all the way out the rack assembly will engage the rack stops and prevent removal.

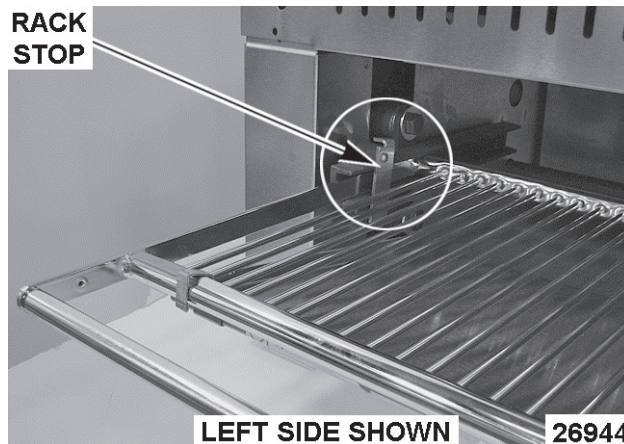

Fig. 12

3. Grasp the rack assembly near the broiler, rotate both the rack stops horizontally and pull the rack assembly out enough for the rack assembly frame to clear the rack stops.

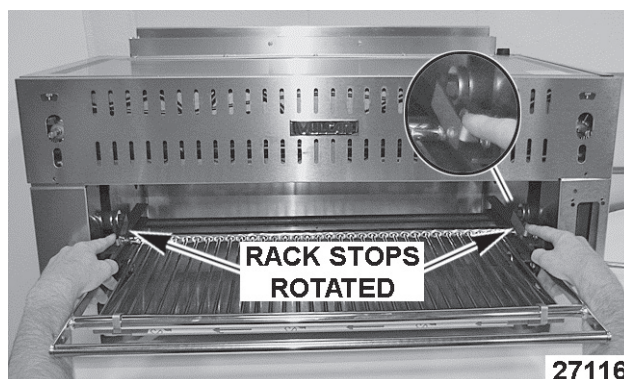

Fig. 13

4. Grasp the rack assembly and drip tray on each side to support the tray and remove from broiler.

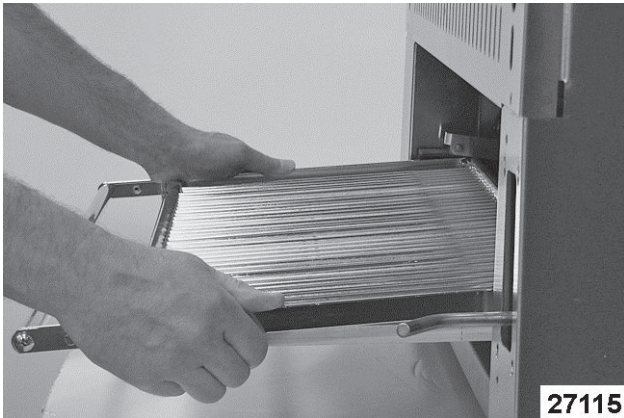

Fig. 14

5. From inside broiler cooking area, remove cotter pin securing burner to broiler frame. Retain pin for reuse.

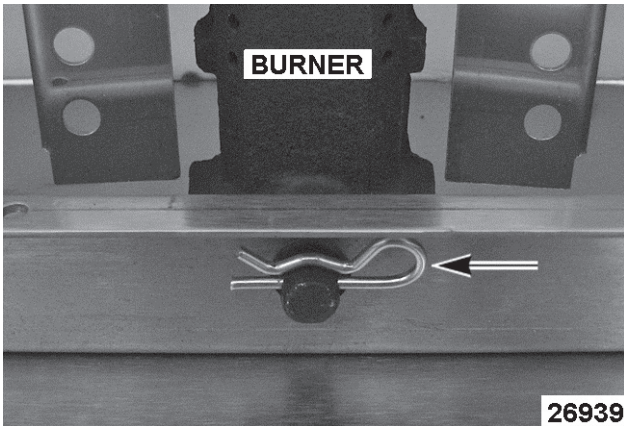

Fig. 15

6. Lift burner from the rear and slide it off the gas orifice to remove from broiler.

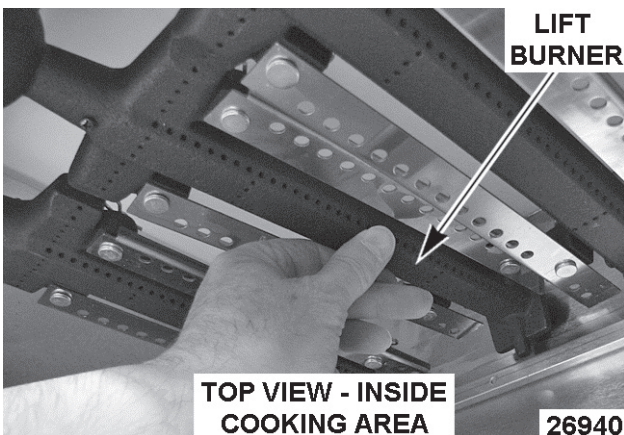

Fig. 16

7. Reverse procedure to install.
8. Perform RADIANT BURNER AIR SHUTTER ADJUSTMENT (36RB/C36RB).

## CONTROL VALVES (36IRB/C36IRB)

**⚠ WARNING** Shut off the gas before servicing the unit.

**⚠ WARNING** All gas joints disturbed during servicing must be checked for leaks. Check with a soap and water solution (bubbles). Do not use an open flame.

1. Remove MANIFOLD COVER.
2. Left Valve:
  - A. Remove screws securing valve mounting bracket to broiler
  - B. Disconnect compression fitting from the elbows at the top and bottom of valve.
  - C. Note orientation of elbows on valve then remove the elbows. Retain for use on replacement valve.

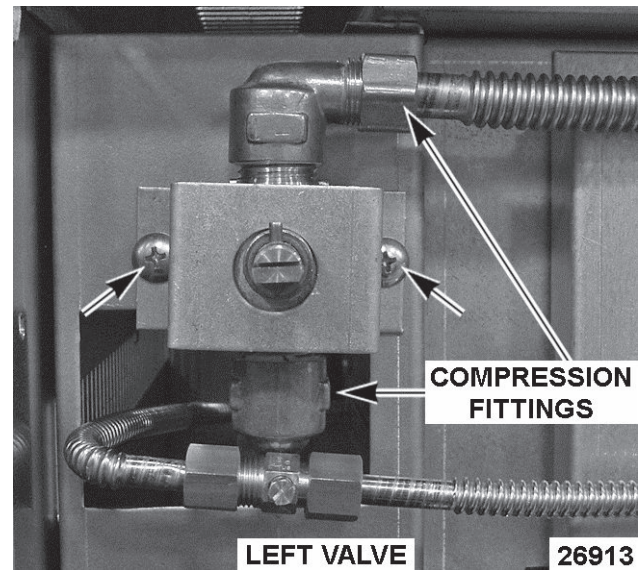

Fig. 17

3. Right Valve:
  - A. Remove screws securing valve stem assembly to valve.



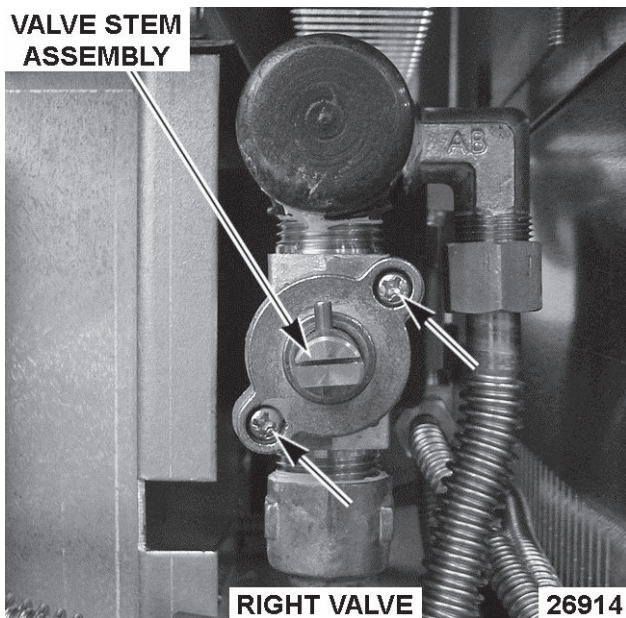

Fig. 18

- B. Note location of spring and remove it if still inside valve body.

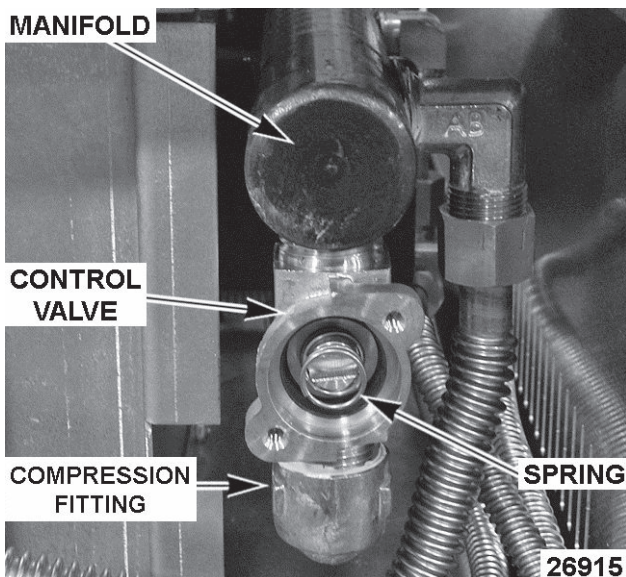

Fig. 19

- C. Disconnect compression fitting from the elbow at the bottom of valve.  
 D. Remove valve from manifold.  
 E. Note orientation of elbow on valve then remove the elbow. Retain for use on replacement valve.

**⚠ WARNING** Clean pipe threads and apply thread sealant that is suitable for use with propane gases.

**NOTE:** When installing: Right valve - apply a light coat of valve grease under the stop on the valve stem (see LUBRICATION). Left & Right Valves - Ensure control valves are aligned and centered in the manifold cover opening. The valves must be perpendicular to the manifold.

4. Reverse procedure to install.
5. Check for proper operation.

### PILOT (36IRB/C36IRB)

**⚠ WARNING** Shut off the gas before servicing the unit.

**⚠ WARNING** All gas joints disturbed during servicing must be checked for leaks. Check with a soap and water solution (bubbles). Do not use an open flame.

1. Remove MANIFOLD COVER, LEFT SIDE PANEL if replacing left pilot and RIGHT SIDE PANEL if replacing right pilot.
2. From inside the broiler cooking area, disconnect compression fitting from the pilot.

**NOTICE** When disconnecting compression fitting for the pilot, support bracket to prevent bending.

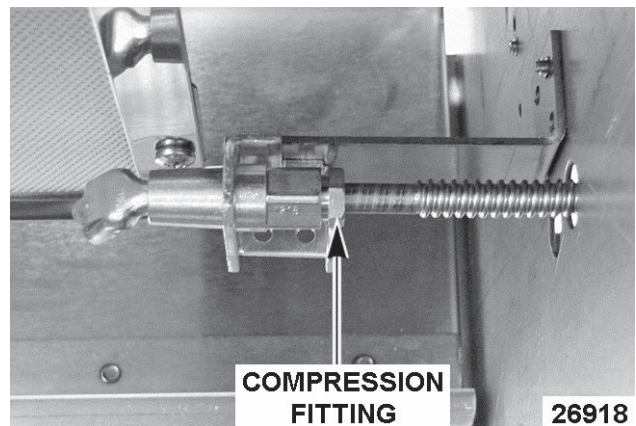

Fig. 20

3. Remove screws securing pilot and bracket to the broiler.

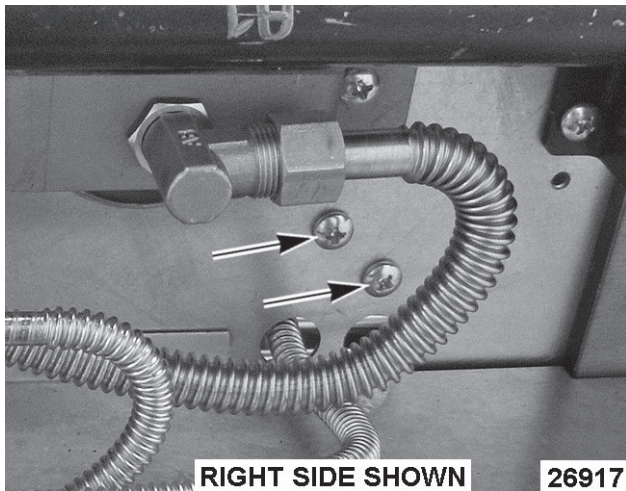

Fig. 21

4. Remove screws securing pilot to the bracket.

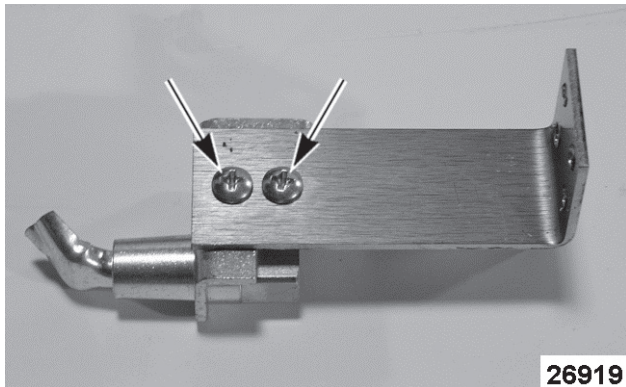

Fig. 22

5. Reverse procedure to install and check for proper operation.

### INFRARED BURNER (36IRB/ C36IRB)

**⚠ WARNING** Shut off the gas before servicing the unit.

**⚠ WARNING** All gas joints disturbed during servicing must be checked for leaks. Check with a soap and water solution (bubbles). Do not use an open flame.

1. Remove MANIFOLD COVER, LEFT SIDE PANEL and RIGHT SIDE PANEL.

2. Remove TOP PANEL ASSEMBLY.

3. **Left side:**

- A. Remove screws securing burner mounting bracket to broiler frame.

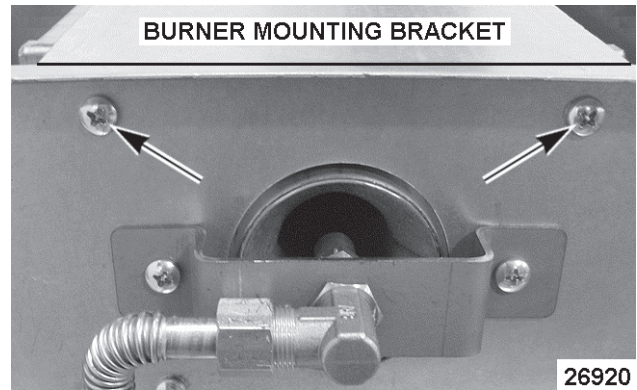

Fig. 23

4. **Right side:**

- A. Disconnect gas supply at broiler.
- B. Remove screws securing manifold to broiler.

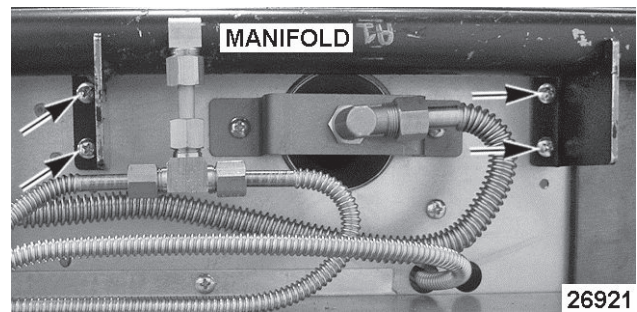

Fig. 24

- C. Lower the manifold to access burner mounting bracket screws.
- D. Remove screws securing burner mounting bracket to broiler frame.

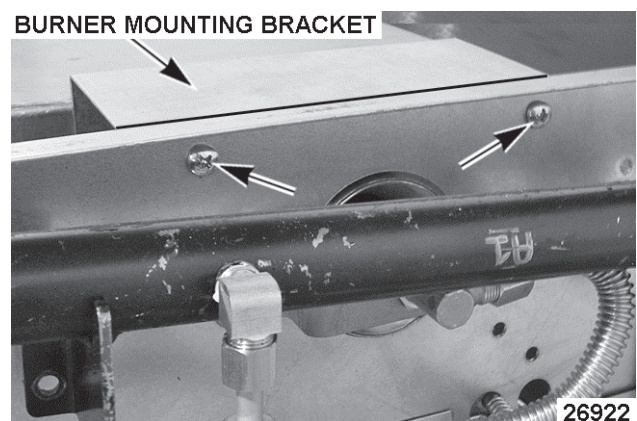

Fig. 25

- E. Disconnect compression nut from elbow orifice fitting to access the right side orifice bracket mounting screw.
- F. Remove screws securing orifice bracket to broiler frame.

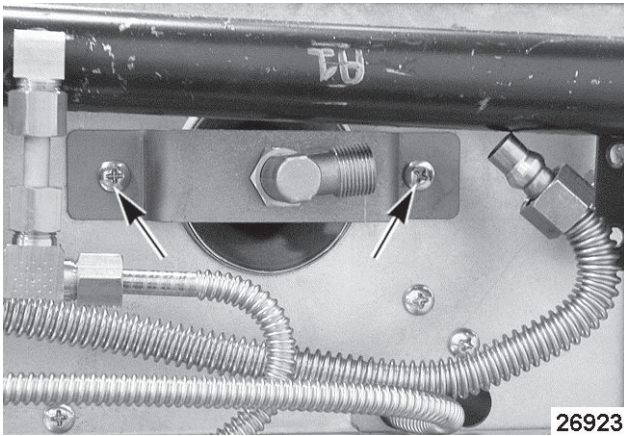

Fig. 26

- From inside the broiler cooking area, remove screws on the of bottom right side of the burner. The screws secure the burner mounting bracket to the burner.

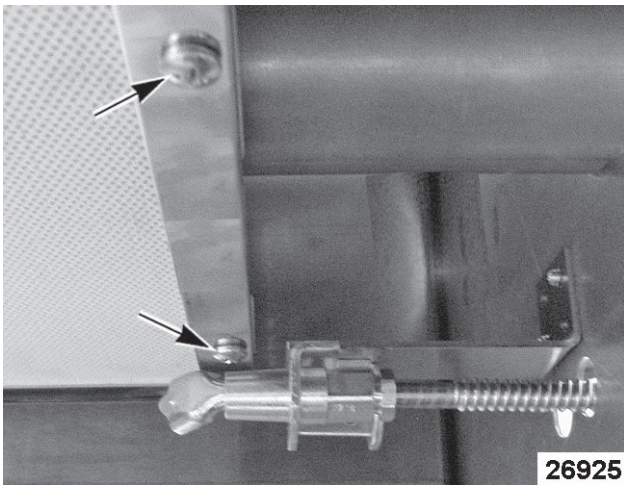

Fig. 27

- Lift right side burner mounting bracket from burner and broiler frame.

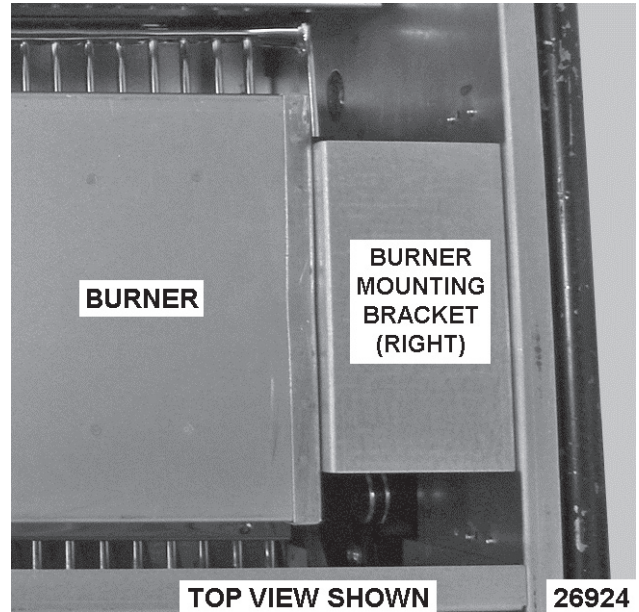

Fig. 28

- Slide burner to the right (manifold side) until it clears the burner opening in broiler frame on the left. Lift burner to remove it from broiler.
- Remove screws securing the left burner mounting bracket to burner.

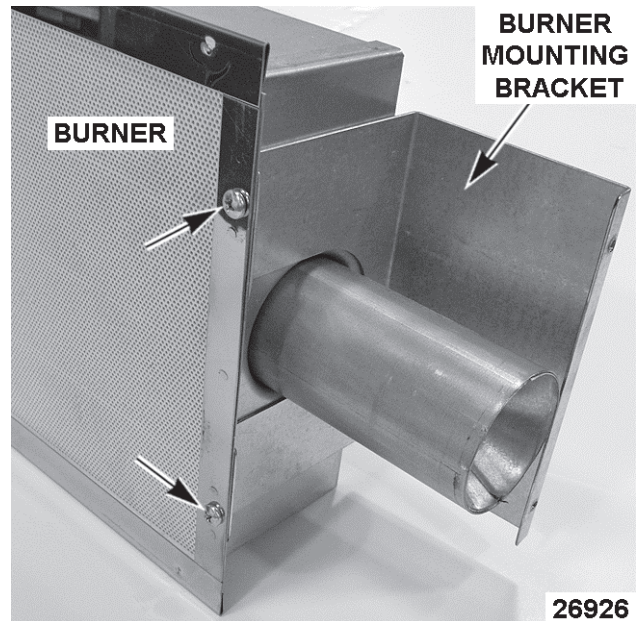

Fig. 29

- Reverse procedure to install replacement burner.
- NOTE:** When installing, remove the left side orifice bracket from the broiler for additional burner clearance as necessary.
- Check for proper operation.

## GAS PRESSURE REGULATOR

**⚠ WARNING** Shut off the gas before servicing the unit.

**⚠ WARNING** All gas joints disturbed during servicing must be checked for leaks. Check with a soap and water solution (bubbles). Do not use an open flame.

**⚠ WARNING** Clean pipe threads and apply thread sealant that is suitable for use with propane gases.

**NOTE:** Gas pressure regulator should be installed as close to the broiler inlet gas connection as possible.

1. Thread regulator onto pipe hand tight with arrow pointing in direction of gas flow to the broiler.

### REGULATOR ADJUSTMENT (BELOW CLOSING NUT)

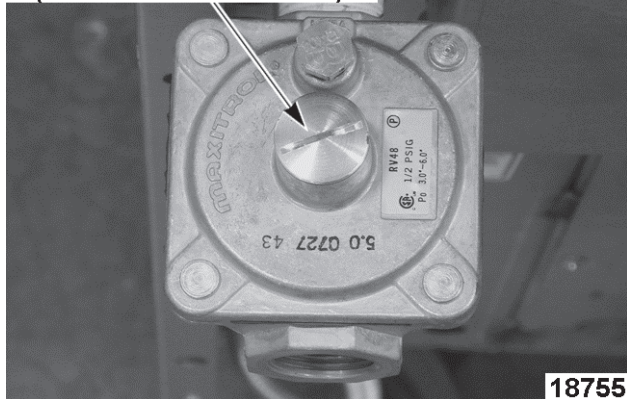

Fig. 30

2. Tighten regulator securely in horizontal position with the regulator adjustment upward as described on regulator.

**NOTE:** Regulator will not function properly without adjustment screw pointing upward.

3. Connect main gas supply line to gas pressure regulator inlet.

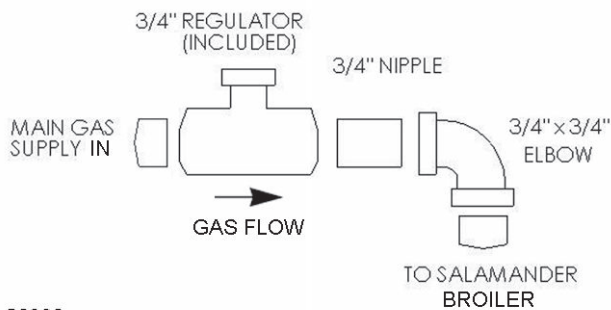

Fig. 31

4. Adjust regulator as outlined in REGULATOR ADJUSTMENT.

## RACK SPRINGS

**NOTE:** Springs should be replaced in pairs for proper operation of the rack lift assembly.

1. Remove crumb tray to access tension adjustment nuts from the front of broiler.
2. Raise the rack lift assembly to its highest position on stop plate to relieve spring tension.
3. Loosen nuts to remove any remaining tension on springs.
4. Access the bottom of broiler and remove springs from the lower arm casting and eye bolt.

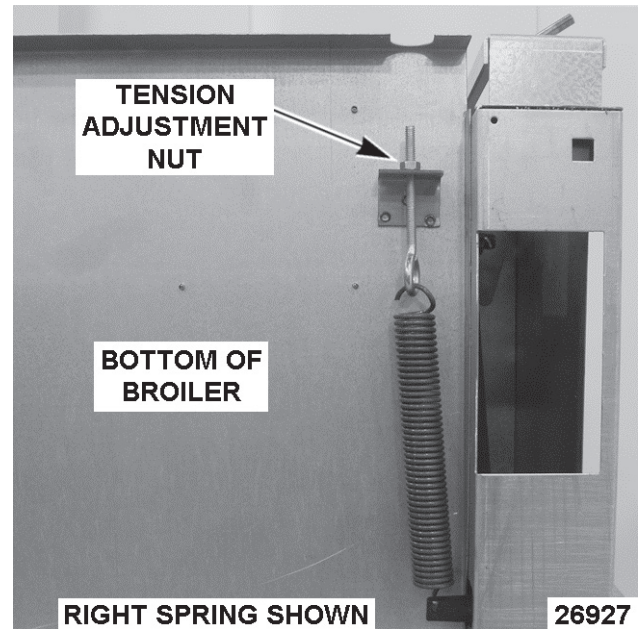

Fig. 32

5. Reverse procedure to install.
6. Perform RACK SPRING TENSION ADJUSTMENT.

26906

# SERVICE PROCEDURES AND ADJUSTMENTS

## PILOT FLAME HEIGHT

1. Locate the pilot adjustment screws below the burner control knobs (one on each side) on the front of broiler. It is not necessary to remove the manifold cover as adjustment access holes are provided in the panel.

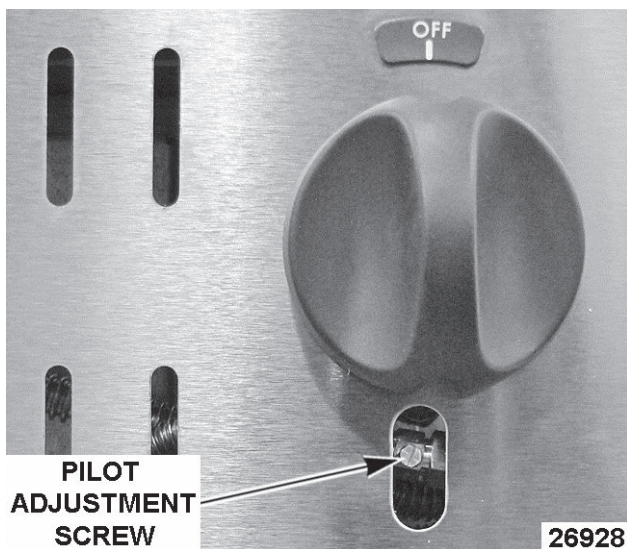

Fig. 33

2. Locate the pilots at the top of the broiler heating area.
3. Monitor the pilots flame and burner lighting. Pilot is in adjustment when it will stay on continually and lights the burners without delayed ignition.
4. If adjustment is necessary, rotate the screw clockwise to decrease and counterclockwise to increase flame height.

## RADIANT BURNER AIR SHUTTER ADJUSTMENT (36RB/C36RB)

The efficiency of the burner depends on a delicate balance between the air supply and volume of gas. Whenever this balance is disturbed, poor operating characteristics and excessive gas consumption may occur. An air shutter on the front of the burner controls the gas mixer balance. A yellow streaming flame on the burner is an indication of insufficient primary air.

To correct this condition, loosen the shutter screw and rotate the air shutter open until the flame begins to lift from the burner, then close the shutter slightly and tighten the shutter screw. A proper flame should be blue in color, well-defined and seated on the burner

port. A white-blue flame is a result of excessive primary air.

**NOTE:** The factory default air shutter positions are half open natural; full open propane.

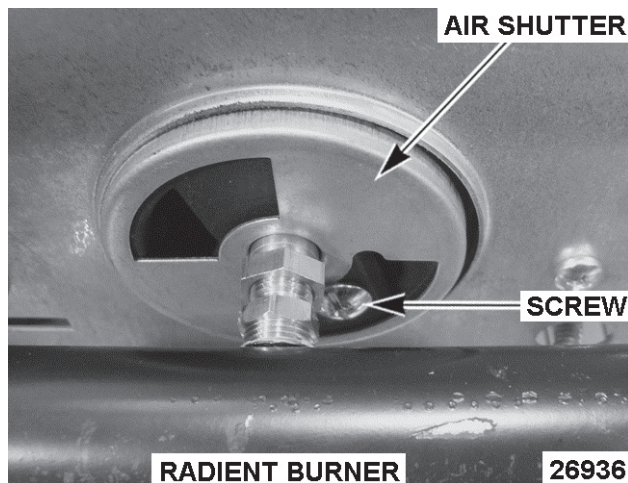

Fig. 34

## INFRARED BURNER (36IRB/C36IRB)

### Adjustment

The only adjustment for the Infrared burner is the gas manifold pressure. Verify the pressure is set correctly as outlined under REGULATOR ADJUSTMENT.

### Flame Appearance

When the Infrared burner first lights you should see a small rolling blue flame, which will clear up after the burner warms. Once warm, a low profile orange flame is the best description of the Infrared burner flame. In some cases, if the burner is operating correctly, you may not be able to see the actual flame. Instead you will see the glow of the ceramic bricks in the burner.

## REGULATOR ADJUSTMENT

**⚠ WARNING** Shut off the gas before servicing the unit.

**NOTE:** Regulators come preset, but should be checked anytime one is installed. Before adjusting regulator, check incoming gas line pressure. Incoming pressure must be 6-14" W.C. for natural gas and 11-14" W.C. for propane gas. If incoming pressure is not correct, have the gas source checked and adjusted as necessary. Make sure the regulator is mounted in the horizontal position with the arrow pointing in the direction of gas flow. See GAS

**PRESSURE REGULATOR under REMOVAL AND REPLACEMENT OF PARTS.**

See unit data plate, under crumb tray, for manifold pressure setting information. Clean vent cap before adjusting.

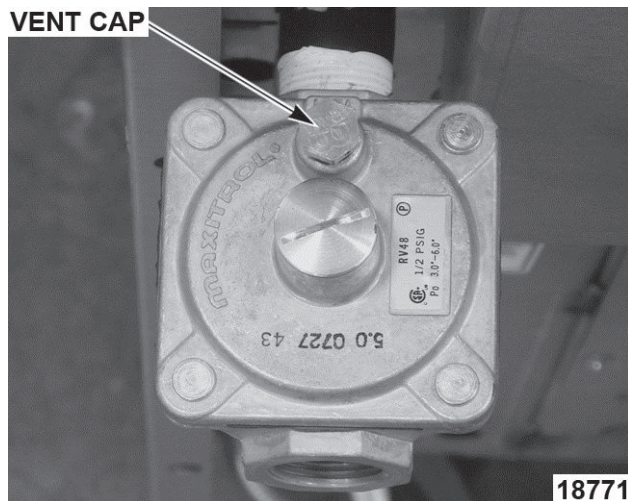

**Fig. 35**

1. Connect manometer to measure gas manifold pressure.
  - A. 36RB/C36RB - Remove **MANIFOLD COVER** to access pressure tap on the manifolds.
  - B. 36IRB/C36IRB - Install a tee with hose barb connection on the outlet side of the regulator. See **TOOLS**. Connect the opposite end of the tee to broiler incoming gas supply.
2. Turn gas supply on and light both pilots.
3. Open both valves to the full on position and check manometer reading. The reading should be 5" W.C. for natural gas and 10" W.C. for propane gas. Tolerance is  $\pm 0.3$ " W.C.
4. If manifold pressure is not correct, adjust the regulator as follows.
  - A. Remove the regulator closing nut.

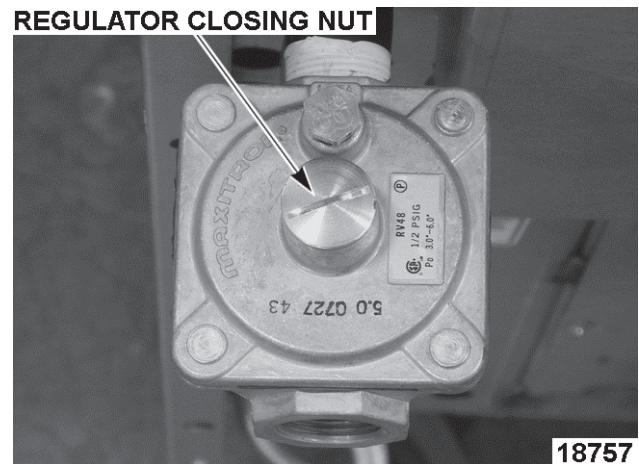

**Fig. 36**

- B. Insert a flat edge screwdriver through the top of the regulator. While watching the manometer, turn the adjusting screw clockwise to increase pressure and counterclockwise to decrease pressure until the proper gas pressure is achieved. See data plate under crumb tray.
- C. Install the regulator closing nut.
- D. Turn gas supply off.
- E. Remove manometer from pressure tap location. If tee was installed, remove tee.

**⚠ WARNING** Clean pipe threads and apply thread sealant that is suitable for use with propane gases.

- F. Apply thread sealant to pipe threads and re-install.

**GAS ORIFICE CHECK**

The gas orifice is mounted at the gas and air inlet for the burner. If burner operation seems poor and other systems have been checked, access the burner and inspect:

- Gas orifice alignment - orifice should be centered in the venturi opening and perpendicular to the burner.
- Check gas orifice for blockage or damage. If dirty, clean with air or water only.
- Verify gas orifice is correct for the altitude.

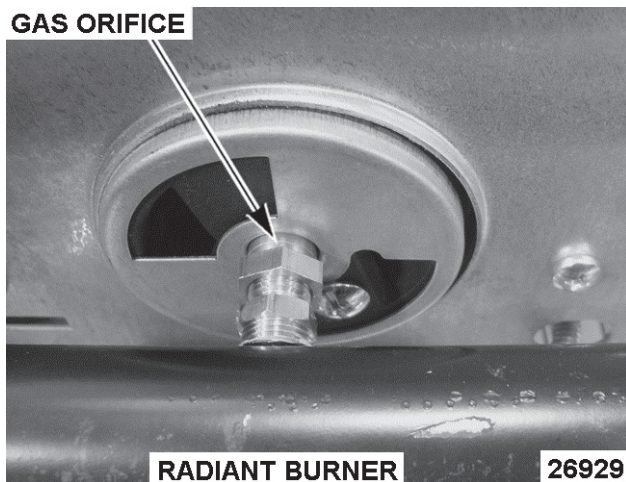

Fig. 37

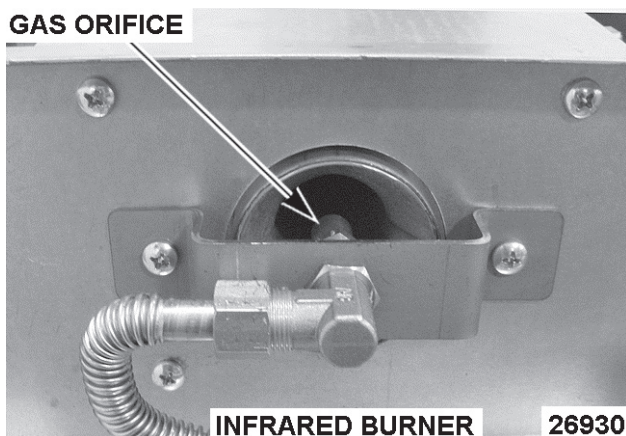

Fig. 38

## CONTROL VALVES

Inspect the control valve for smooth rotation, noticeable wear and any possible damage. The burner flame should increase smoothly as the valve is opened (highest setting) and decrease smoothly as the valve is being closed. When inspecting valves, always apply a light amount of valve grease at the base of the valve stem. See [LUBRICATION](#). If valve grease does improve rotation of the valve, or damage is found, replace the control valve as outlined under [CONTROL VALVES \(36RB/C36RB\)](#) or [CONTROL VALVES \(36IRB/C36IRB\)](#).

## RACK SPRING TENSION ADJUSTMENT

1. Access the springs on the bottom of broiler.
2. Tighten nut to adjust rack spring tension. Adjust both springs equally so there is approximately 3/4" of thread above the nut. If additional rack spring tension is required, tighten each nut an additional 2-3 turns.

3. Check for proper operation.

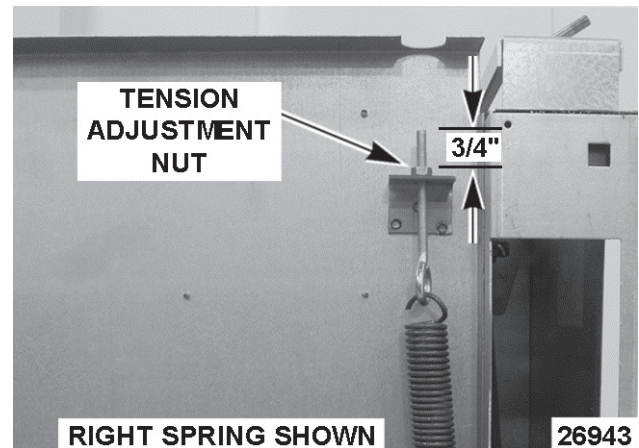

Fig. 39

# TROUBLESHOOTING

## GENERAL (ALL MODELS)

| GENERAL                         |   |
|---------------------------------|---|
| SYMPTOM                         | POSSIBLE CAUSE  |
| Pilot does not remain lit.      | <ol style="list-style-type: none"> <li>1. Incorrect gas type.</li> <li>2. Incorrect gas pressure.</li> <li>3. Pilot burner not adjusted properly.</li> <li>4. Pilot burner blocked or Incorrect pilot orifice.</li> </ol> |
| Slow to heat or not hot enough. | <ol style="list-style-type: none"> <li>1. Incorrect gas type.</li> <li>2. Low gas pressure.</li> <li>3. Regulator adjustment or malfunction.</li> <li>4. Control valve malfunction.</li> </ol>                            |
| Broiler temperature too hot.    | <ol style="list-style-type: none"> <li>1. Incorrect gas type.</li> <li>2. Regulator adjustment or malfunction due to high gas pressure.</li> <li>3. Control valve malfunction.</li> </ol>                                 |

## RADIANT BURNER (36RB/C36RB)

| RADIANT BURNER                        |   |
|---------------------------------------|---|
| SYMPTOM                               | POSSIBLE CAUSE  |
| Flame too yellow.                     | <ol style="list-style-type: none"> <li>1. Orifice incorrect size or dirty.</li> <li>2. Air shutter not adjusted correctly or dirty.</li> <li>3. Incorrect gas pressure.</li> <li>4. Incorrect gas type.</li> <li>5. Orifice not aligned properly in venturi.</li> <li>6. Appliance not venting properly.</li> </ol> |
| Low burner flame (all burners).       | <ol style="list-style-type: none"> <li>1. Regulator adjustment or low gas pressure.</li> <li>2. Incorrect gas type.</li> </ol>  |
| Low burner flame (individual burner). | <ol style="list-style-type: none"> <li>1. Air mixture incorrect.</li> </ol>   |
| Flame floats on burner.               | <ol style="list-style-type: none"> <li>1. Inadequate air supply.</li> <li>2. Restricted exhaust flue.</li> </ol>  |

## INFRARED BURNER (36IRB/C36IRB)



| <b>INFRARED BURNER</b>  |   |
|---|---|
| <b>SYMPTOM</b>  | <b>POSSIBLE CAUSE</b>   |
| Flame not orange.   | <ol style="list-style-type: none"> <li>1. Orifice incorrect size or dirty.</li> <li>2. Incorrect gas pressure.</li> <li>3. Incorrect gas type.</li> <li>4. Orifice not aligned properly in venturi.</li> <li>5. Appliance not venting properly.</li> <li>6. Clogged burner ports.</li> <li>7. Burner malfunction.</li> </ol>  |
| Burner not lighting properly or incorrect burner flame appearance due to clogged ports. | <ol style="list-style-type: none"> <li>1. Broiler with Infrared burner is mounted too close to a fryer or charbroiler and the grease laden air is causing burner ports to clog. If burner ports are found to be clogged, install a replacement burner.<br/><br/><b>NOTE:</b> Grease laden air is detrimental to the life of the Infrared burner. If a technician sees a broiler with Infrared burner mounted in a location close to a fryer or charbroiler, please recommend to the customer to move the broiler away from the grease laden air source to prolong the life of the Infrared burner.</li> </ol> |